

Aerials | Dishes | Receivers | Headends | Multi switches | Amplifiers | Outlets | Home accessories | Fibre cabinets | Enclosures

Convincing technology - faster mounting

New antenna outlet socket generation





TRIAX - your ultimate connection

New generation antenna outlet sockets

Convincing technology and mounting

The advantages of the new antenna outlet sockets generation:

-  **comfortable mounting**
-  **excellent electrical parameters**
-  **reliable and durable**

Antenna outlet sockets are used for the individual connection of subscriber terminal equipment such as TV receiver, FM radio, sat receiver or cable modem to the cable TV network or the house antenna system.

In view of their versatility Triax recommends universal antenna outlets for installation in general residential buildings. If the future application is limited to only one type of network operation such as direct satellite reception or cable TV with Internet access, specially designed satellite or wide-band socket boxes are the alternative.

The connectors are designed as IEC connectors or F-connectors. The number and combination of the connectors of a outlet type depends on the subscriber terminal equipment that is common for the respective type of network. However, it is also influenced by specific national and operator requirements resulting in an increased variety of types.



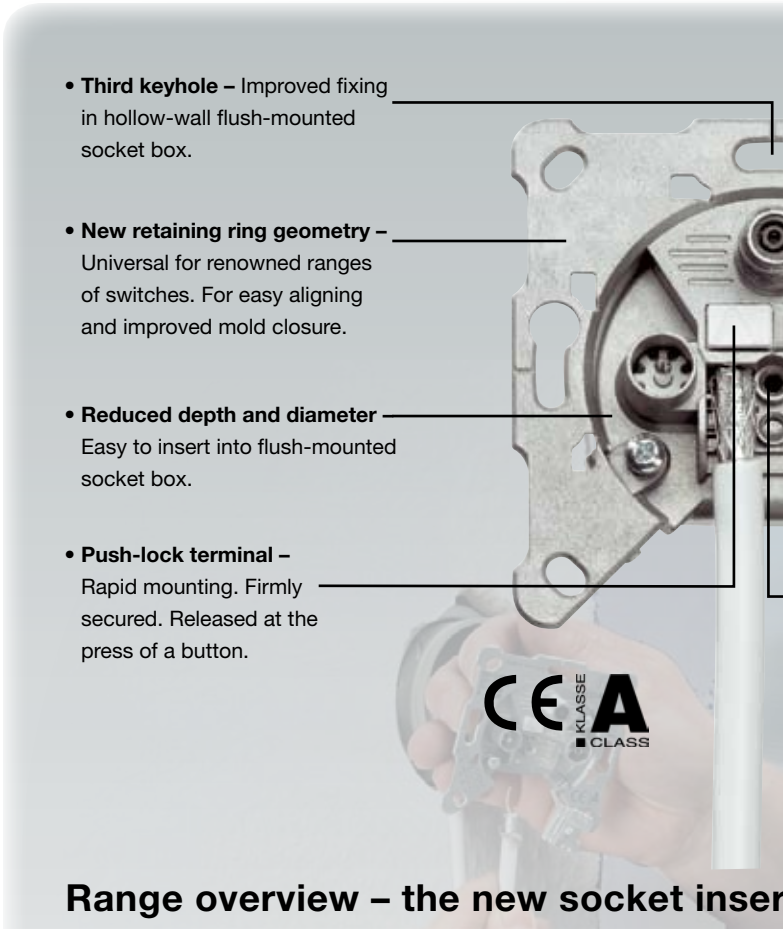







The stable diecast frame of the Triax sockets has been optimized for installation in round size-55 flush-mounted socket boxes. The AR 20 frame (accessory) alternatively allows surface mounting. The AD 23 cover (accessory) is a cover available for 2- or 3-hole socket boxes. The retaining ring form of the socket inserts has been agreed with renowned switch manufacturers so that the decorative covers from their corresponding designer ranges can also be used.



- **Third keyhole** – Improved fixing in hollow-wall flush-mounted socket box.
- **New retaining ring geometry** – Universal for renowned ranges of switches. For easy aligning and improved mold closure.
- **Reduced depth and diameter** – Easy to insert into flush-mounted socket box.
- **Push-lock terminal** – Rapid mounting. Firmly secured. Released at the press of a button.

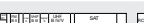
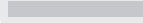
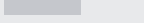

Range overview – the new socket insert

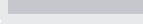
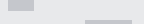
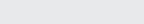
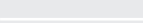
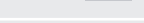
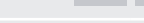
Type	Universal	Sat	Sat
Connectors			
 IEC male tv			
 IEC female radio			
 F female sat/data			
Antenna outlet type	Super wide-band	Sat/CATV combination	Sat filter
Single type	EDU 04F GAD 204F	EDA 302F	EDS 01
Pass-through type	GEDU 10, 15, 20 GAD 210, 214, 220	GDA 313 F GAD 313 F	GDS 08, 11
Frequency ranges			
Tv			
Radio			
Sat/data			
Terminal equipment	Tv-set FM radio DVB-C/-T receiver	Sat receiver Tv-set FM radio DVB-C/-T receiver	Sat receiver DVB-T receive Tv-set

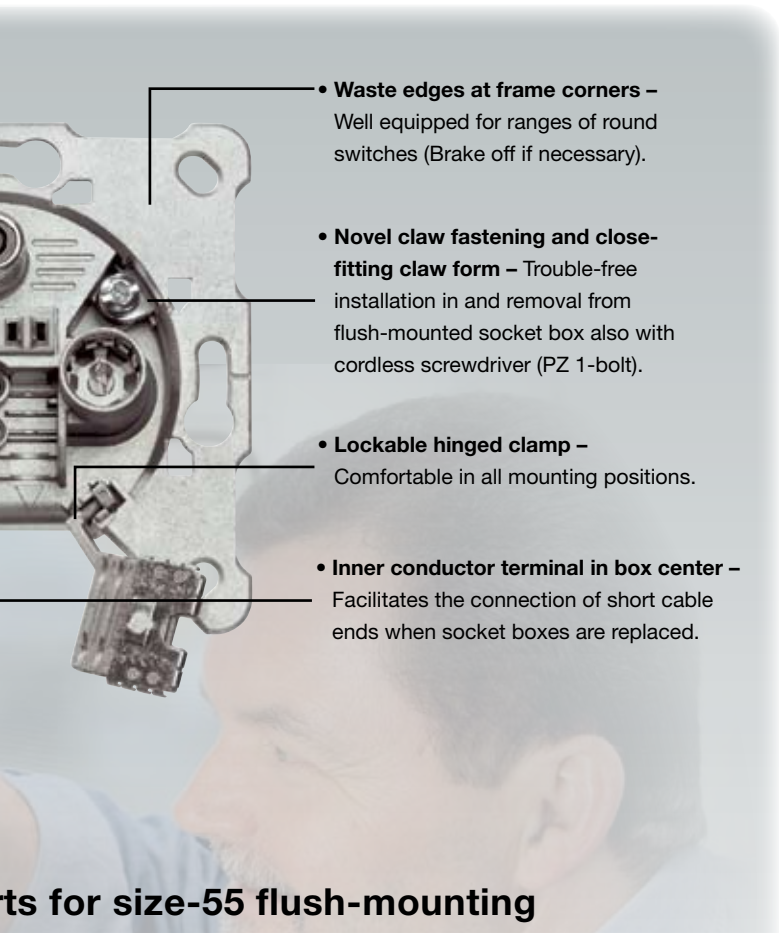

- **Waste edges at frame corners –**
Well equipped for ranges of round switches (Brake off if necessary).
- **Novel claw fastening and close-fitting claw form –** Trouble-free installation in and removal from flush-mounted socket box also with cordless screwdriver (PZ 1-bolt).
- **Lockable hinged clamp –**
Comfortable in all mounting positions.
- **Inner conductor terminal in box center –**
Facilitates the connection of short cable ends when socket boxes are replaced.

ts for size-55 flush-mounting

CATV/MATV

TWIN sat	Sat filter	CATV modem	CATV modem	CATV filter (DC/AC isolated)
EDS 322	FS 302 F	EDM 306	EDM 304	EDC 01 NL
		GDM 312 GDM 316	GDM 310 GDM 315	
win sat receiver DVB-T receiver Tv-set	Sat receiver DVB-T receive Tv-set	Tv-set FM radio Cable modem DVB-C receiver	Tv-set FM radio Cable modem DVB-C receiver	Tv-set FM radio

Mounting in detail

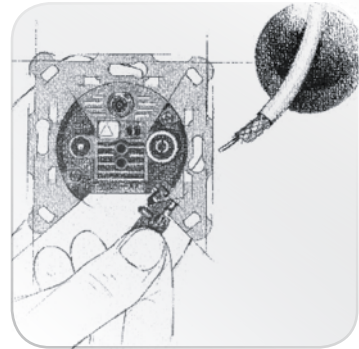

Open
Opened simply. Use a screwdriver to lever out the hinged clamp at the recess. In order to allow free mounting position tilt hinged clamp into fixing position.

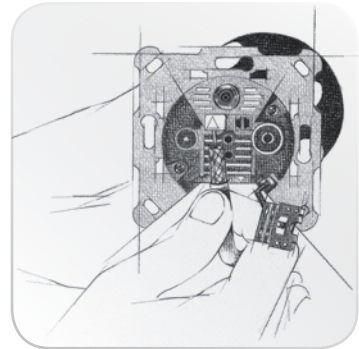

Insert
The new technology for inner conductor contact-ing. Simply insert the stripped coaxial cable into the spring contact until it stops – it is held securely. In order to remove the cable press the button and remove the cable.

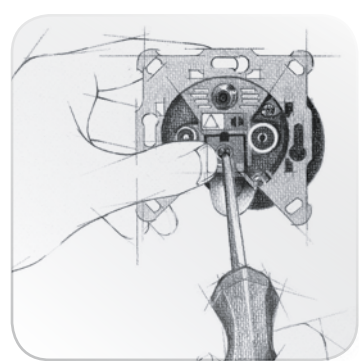

Close
Close the hinged clamp and screw it tight. Insert the socket body, align it using the straight edges and anchor it by tightening the claw screws. PZ 1 screws for cord-less screwdriver.



TRIAx - your ultimate connection

Improved functionality with forward-looking technology

Two basic types of outlets

- Single outlet sockets are used to terminate the decoupled branch lines coming from the multi-tap, multi-switch or satellite LNB (star topology).
- Pass-through outlet sockets can also be cascaded (tree topology). The last socket box at a main line or spur is to be provided with a terminating resistor (refer to accessories).

Electrical design

- The filter principle used in most satellite and MATV/CATV outlets provides lowest distribution operating loss as well as additional selective decoupling. These advantages are achieved at the price of transition ranges between the frequency bands that cannot be used.
- Wide-band splitters or directional couplers, on the other hand, transmit the frequency ranges without any gaps. This requires a connection attenuation that is approx. 3 dB higher at single socket boxes. A corresponding example is the super wide-band antenna outlets.
- Both technologies are combined in the Sat-/CATV-combination outlet sockets and in the modem outlets in order to enjoy the advantages of both principles.

Quality

- With the coil on board technology the filigree ferrit core transformer is wound, soldered and its circuiting checked directly on the circuit board.
- 100 percent end check of the most important socket parameters during production.
- Product of the Triax Group. The fully-automatic production line in Denmark ensures the design quality for the whole series.

Transportation formats of antenna socket boxes:

- 10 socket boxes in pocketed group packages
229 x 142 x 75 mm
- 100 socket boxes (10 packages) in cardboard box
385 x 285 x 230 mm
- 3,000 socket boxes per Euro-pallet

Transparent blister packaging for a socket box with AD 23 cover on request.

General technical data

Operating conditions		
Temperature range	-25° to +55° C	ETSI 300 019-1-3 Class 3.3 stationary, water-protected
Reliability (MTBF)	> 1 million hours	Belcore @ 25° C
Connected values		
Terminal impedance	75 Ohm	All RF connections
DC load	Max. 24V/0,5 A/22 kHz	Only via SAT connections
Screen attenuation	Class A	EN 50 083-2
	> 85 dB	30 - 300 MHz
	> 80 dB	300 - 470 MHz
	> 75 dB	470 - 1000 MHz
> 55 dB	1000 - 2400 MHz	
Mechanical elements		
Socket box body	Torsionally rigid passivated zinc diecast	
Weight	Approx. 90 g	
"TV" outlet	IEC male connector	IEC 60 169-2
"RF" outlet	IEC female connector	IEC 60 169-2
"SAT"/"DATA" outlet	F socket	IEC 60 169-24

Installation dimensions

Outlet socket frame

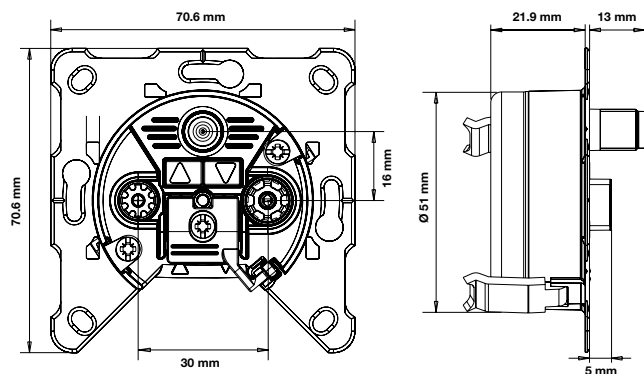

Recommended cable dimensions

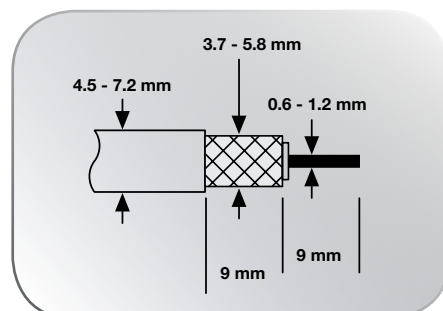

Universal antenna outlets

- Designed for CATV (cable TV) and Sat IF distribution.
- Continuous CATV frequency ranges with reverse channel capability.
- Advantage: Flexible in application and storage.
- Manifold connection alternatives for the terminal equipment.

2-outlet super wide-band sockets

Type		EDU 04 F	GEDU 10	GEDU 15	GEDU 20
Art. No.		306111	306211	306212	306213
Design		Single socket	Pass-through-socket		
Attenuation	Frequency range				
IN - OUT (pass-through)	5 to 2150 (2400) MHz	-	2.5 dB	1.0 dB	0.8 dB
IN - TV (IEC male)	5 to 2150 (2400) MHz	4.0 dB	10 dB	15 dB	20 dB
IN - RF (IEC female)	5 to 2150 (2400) MHz	4.0 dB	10 dB	15 dB	20 dB
Isolation					
OUT - TV/RF	VHF, UHF / SAT	-	35/20 dB	38/30 dB	40/30 dB
TV - RF	VHF, UHF / SAT	20/20 dB	38/30 dB	24/24 dB	24/22 dB
DC circuit	13/18V, 22 kHz; max. +24V/0,5 A	TV-IN (IEC-connector)	no	no	no

- Wideband socket box with Sat IF range
- Continuous frequency ranges 5 to 2,400 MHz on both outlets (universal socket box)
- **Advantage:** Upgrading or retrofitting of the wideband house network with direct satellite reception always possible

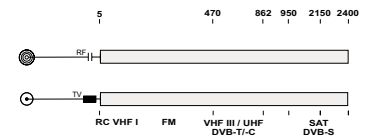
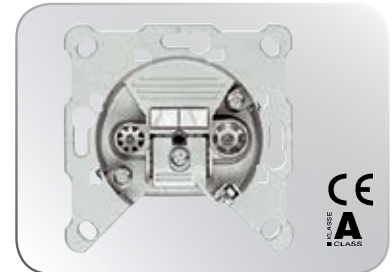

3-outlet sat/CATV combination sockets

Type		EDA 302 F	GDA 313 F
Art. No.		306121	306221
Design		Single socket	Pass-through-socket*
Attenuation	Frequency range		
IN - OUT (pass-through)	5 to 2150 (2400) MHz	-	1.0-2.0 (2.8) dB
IN - TV (IEC male)	5 to 862 MHz	2.5 dB	13 dB
IN - RF (IEC female)	5 to 118 MHz	6.5 dB	17 dB
IN - SAT (F female)	950 - 2150 (2400) MHz	2.2 dB	12 (13.5) dB
Isolation			
OUT - TV/RF	VHF, UHF	-	28 dB
OUT - SAT	SAT	-	18 dB
TV - SAT	VHF, UHF / SAT	20/20 dB	20/20 dB
RF - SAT	VHF / SAT	35/30 dB	35/30 dB
TV - RF	VHF, UHF	20 dB	20 dB
DC circuit	13/18V, 22 kHz; max. +24V/0.5 A	SAT-IN (F socket)	SAT -> IN; IN-OUT - circuit

- Sat IF socket box with reverse-channel capable wide-band MATV/CATV outlets (splitter-filter combination)
- GDA 313 F pass-through-socket with diode-decoupled DC circuit (13/18V, 22 kHz) for single-cable solution and satellite sub-distributions* in the residential unit
- **Advantage:** In addition to Sat IF operation, connection options to CATV cable network or terrestrial antenna systems (all-round antenna outlet socket).

*Note:

Only one sat receiver can be operated actively at the socket box chain in case of a cascade of pass-through sockets in multi-switch operation.

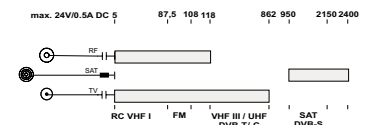
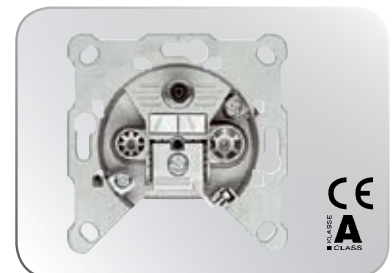

Find the outlet solution
that's right for you at:

www.triax.com



SAT antenna outlets

- Special sat antenna outlets for sat IF distribution networks (multi-switch systems or single-cable solution) as well as single satellite systems.
- F connector for sat IF range. Additional connection of terrestrial receiving devices such as DVB-T receiver possible via IEC connectors.
- Selective splitting of the frequency bands via filters with extremely low distribution operating loss.
- Advantages:
Direct F-connection for sat receiver.
Cost efficient.

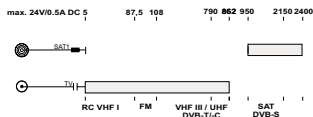
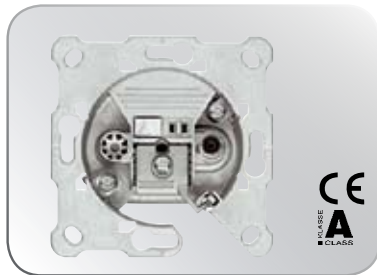

2-outlet sat filter sockets

Type	EDS 01 F	GDS 08 F	GDS 11 F
Art. No.	306131	306231	306232
Design	Single socket	Pass-through-socket*	
Attenuation	Frequency range		
IN - OUT	5 - 2150 (2400) MHz	-	2.4 - 3.2 (4.0) dB 1.0 - 1.8 (2.6) dB
IN - TV (IEC male)	5 - 862 MHz	1.0 dB	8.0 dB 11 dB
IN - SAT (F female)	950 - 2150 (2400) MHz	1.2 dB	8.0 dB 11.5 dB
Isolation			
OUT - TV/SAT	VHF, UHF / SAT	-	30/20 dB 30/20 dB
TV - RF	VHF, UHF / SAT	25/18 dB	25/18 dB 25/18 dB
DC circuit	13/18V, 22 kHz; max. +24V/0.5 A	SAT-IN (F socket)	SAT -> IN; IN-OUT - circuit

- Conceived specially for Sat IF systems with optional DVB-T operation

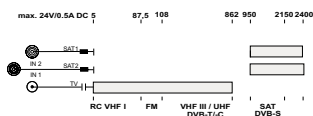

TWIN sat socket

Type	EDS 322 F	
Art. No.	306141	
Design	Single socket	
Attenuation	Frequency range	
IN1 - TV (IEC male)	5 - 862 MHz	1.0 dB
IN1 - SAT1 (F female)	950 - 2400 MHz	1.2 dB
IN2 - SAT2 (F female)	5 - 2400 MHz	1.2 dB
Isolation		
OUT - TV/SAT	VHF, UHF / SAT	20/20 dB
DC circuit	13/18V, 22 kHz; max. +24V/0.5 A	SAT-IN (F female)

- Two independent inputs and F outlets for TWIN-sat receiver operation with connection option for DVB-T receiver or, via adapter coupling, for FM radio

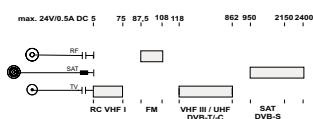
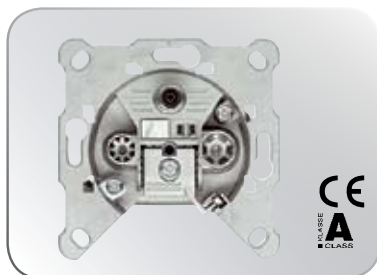

3-outlet sat filter socket

Type	FS 302 F	
Art. No.	306151	
Design	Single socket	
Attenuation	Frequency range	
IN - TV (IEC male)	5 - 75/118...862 MHz	1.5 dB
IN - RF (IEC female)	87 - 108 MHz	1.5 dB
IN - SAT (F female)	950 - 2150 (2400) MHz	2.0 (3.0) dB
Isolation		
TV/RF - SAT	VHF / SAT	30/20 dB
TV - RF	VHF, UHF	20 dB
DC circuit	13/18V, 22 kHz; max. +24V/0.5 A	SAT-IN (F female)

- For sat IF systems (SMATV) with connection options for terrestrial terminal equipment such as FM radio and DVB-T television

***Note:**

Only one sat receiver can be operated actively at the socket box chain in case of a cascade of pass-through-sockets in multi-switch operation.

CATV antenna outlets

- Special antenna outlet sockets for connecting to cable TV networks (CATV) or common antenna networks (MATV/SMATV) up to 1 GHz.
- Special outlets designs for different electrical

requirements (further special antenna outlets on request).

- Advantage: Optimal electrical characteristics for the respective application.

3-outlet modem sockets

Type	EDM 304	GDM 310	GDM 315	
Art. No.	306171	306271	306272	
Design	Single socket	Pass-through-socket		
Attenuation	Frequency range			
IN - OUT	5 - 1000 MHz	-	2.5 dB	1.6 dB
IN - TV (IEC male)	(111) 118 - 1000 MHz	(6.0) 4.3 dB	(13) 11 dB	(17) 15 dB
IN - RF (IEC female)	87 - 108 MHz	6.0 dB	14 dB	18 dB
IN - DATA (F female)	5 - 1000 MHz	3.5 dB	10 dB	15 dB
Isolation				
OUT - TV/RF	5 - 65 MHz/VHF/UHF	-	65/34/30 dB	65/34/30 dB
OUT - DATA	5 - 65 MHz/VHF/UHF	-	32/38/34 dB	35/35/35 dB
DATA - TV/RF	5 - 65 MHz/VHF/UHF	70/30/30 dB	70/40/36 dB	70/40/38 dB

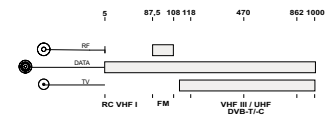
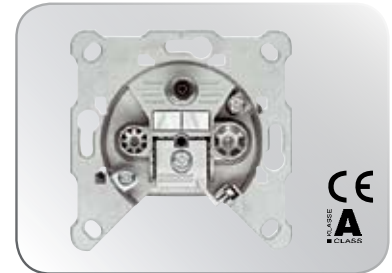

3-outlet modem sockets

Type	EDM 306	GDM 312	GDM 316	
Art. No.	306161	306261	306262	
Design	Single socket	Pass-through-socket		
Attenuation	Frequency range			
IN - OUT	5 - 1000 MHz	-	2.5 dB	(2.0) 2.5 dB
IN - TV (IEC male)	(109) 118 - 1000 MHz	6.0 dB	12.5 dB	15.5 dB
IN - RF (IEC female)	87 - 1000 MHz	6.0 dB	12.5 dB	15.5 dB
IN - DATA (F female)	5 - 1000 MHz	7.8 dB	12.5 dB	15.5 dB
Isolation				
OUT - TV/RF	5 - 65 MHz/VHF/UHF	-	*)	*)
OUT - DATA	5 - 65 MHz/VHF/UHF	-	*)	*)
DATA - TV/RF	5 - 65 MHz/VHF/UHF	70/34/30 dB	*)	*)

- For interactive multimedia CATV networks with cable modem operation
- Reverse channel range (F female) is decoupled by approx. 70 dB against TV outlet in order to avoid incorrect images during cable modem operation

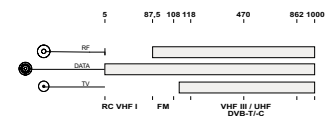

- > 4 MHz min. 30 dB, -1.5 dB/octave acc. EN 50083-4, 40-230 MHz min. 30 dB acc. EN 50083-7

2-outlet CATV special socket with electrical isolation

Type	EDC 01 NL	
Art. No.	306181	
Design	Single socket	
Attenuation	Frequency range	
IN - TV (IEC male)	5 - 75/118 - 862 MHz	1.8 / 0.8 dB
IN - RF (IEC female)	87,5 - 108 MHz	1.8 dB
Isolation		
TV - RF	5 - 862 MHz	12 - 30 dB
DC circuit	Inner conductor TV/RF	capacitive isolated (2 kV)

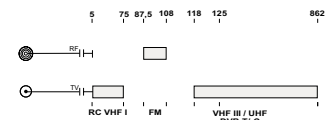
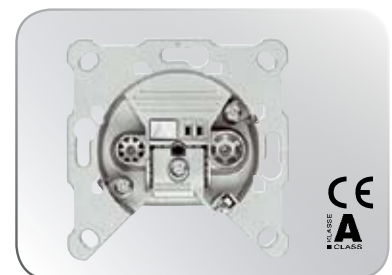

- For CATV networks in the Netherlands and Belgium.

2-outlet MATV filter sockets

Type	FS 01	FS 07	FS 12	
Art. No.	306191	306291	306292	
Design	Single socket	Pass-through-socket		
Attenuation	Frequency range			
IN - OUT	5 - 1000 MHz	-	2.4 dB	1.0 dB
IN - TV (IEC male)	5 - 68/118 to 1000 MHz	0.8 / 0.7 dB	8.0 / 8.0 dB	11 dB
IN - RF (IEC female)	87 - 108 MHz	1.0 dB	9.0 dB	12 dB
Isolation				
OUT - TV/RF	40 - 1000 MHz	-	30 dB	-1,5 dB / Octave

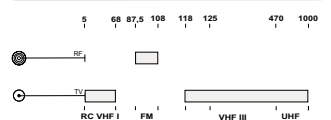
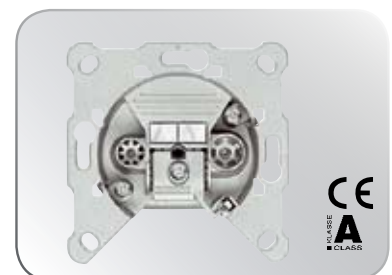

- For wideband community networks (MATV, SMATV) or single terrestrial systems

AR 20 surface-mounted frame



- White
- Ivory
- Dimensions: 81 x 81 mm
- Transportation format: 10/100 pieces

R 77 terminating resistor



- Transportation format: 10/100 pieces
- 75 Ohm for low-reflection terminating of the last pass-through-socket as of the type GDM, GEDU, FS 07, FS 12
- Frequency range 0 - 2400 MHz

AD 23 cover



- White
- Ivory
- Dimensions: 81 x 81 mm
- Transportation format: 10/100 pieces

R 77 DCB terminating resistor



- Transportation format: 5/100 pieces
- 75 Ohm with capacitive isolation for low-reflection termination of the last pass-through-socket as of type GDA, GDS with DC operation
- Frequency range 10 - 2400 MHz

Aerials | Dishes | Receivers | Headends | Multi switches | Amplifiers | Outlets | Home accessories | Fibre cabinets | Enclosures

Note:

Unless nothing to the contrary is stated the technical data in this brochure are typical characteristics averaged across the frequency range and the manufacturing tolerance and are subject to the usual tolerances. All the data, specification and representations correspond to the state valid at the moment of printing.

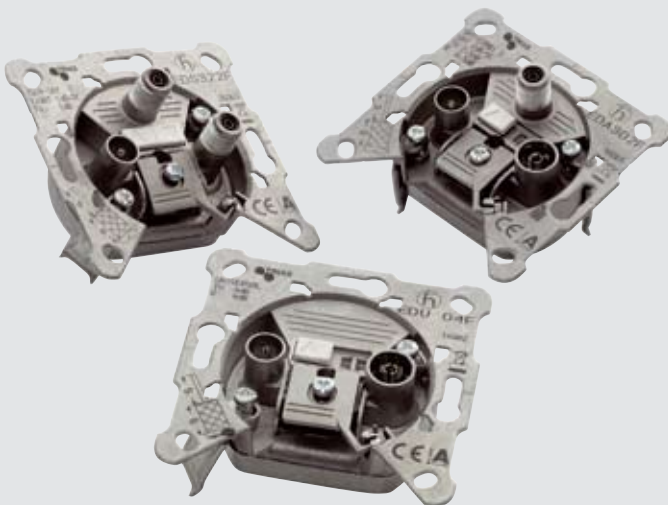

More information:

www.triax.com

TRIAX A/S

Bjørnkærvej 3 • DK-8783 Hornslyd
+45 76 82 22 00 • +45 75 68 79 66
mail: triax@triax.dk • www.triax.com

AB.102.1.02 • Produceret 2008
All specifications in this catalogue are subject to change without notice
Triax Marketing • © 2008 The Triax Group
All rights reserved. Use of this material signifies your agreement to the terms of use.